

# 99276

## Dimensions

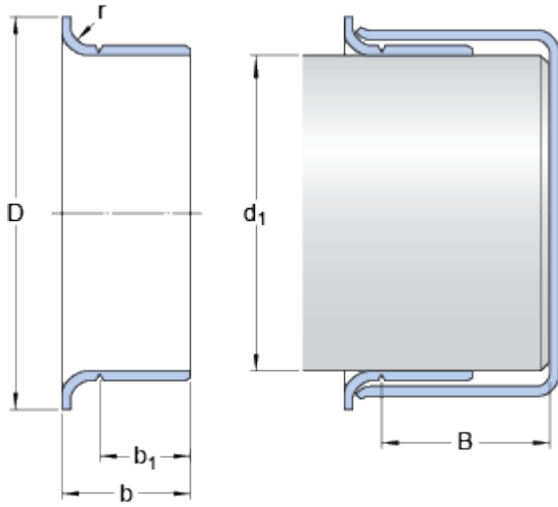

### Nominal dimensions

$d_1$		70	mm
$D$		79.375	mm
Tolerance outside diameter $D$	$\pm$	1.6	mm
$b$		24.003	mm
Tolerance width $b$	$\pm$	0.8	mm
$b_1$		19.99	mm
Tolerance width $b_1$	$\pm$	0.8	mm
$B$	max.	31.75	mm
$r$	max.	3.18	mm

### Shaft diameter range

$d_1$	min.	69.926	mm
$d_1$	max.	70.104	mm